	INDIAN SCHOOL AL WADI AL KABIR	
Class: XII	Department: SCIENCE 2022 - 23 SUBJECT : PHYSICS	Date of submission: 16/05/2022
Worksheet No: 03 WITH ANSWERS	CHAPTER: CURRENT ELECTRICITY	Note: A4 FILE FORMAT
Name of the student:	Class & Sec:	Roll No:

SECTION – A
MCQ BASED QUESTIONS

1. A current passes through a wire of nonuniform cross-section. Which of the following quantities are independent of the cross-section?

- (a) The charge crossing
- (b) Drift velocity
- (c) Current density
- (d) Free-electron density

Ans. d

2. In the equation $AB = C$, A is the current density, C is the electric field, Then B is

- (a) resistivity
- (b) conductivity
- (c) potential difference
- (d) resistance

Answer- a

Explanation:

$$J = \sigma E \Rightarrow J\rho = E$$

J is current density, E is electric field

so $B = \rho = \text{resistivity.}$

3. Drift velocity of electrons is due to
- (a) motion of conduction electrons due to random collisions.
 - (b) motion of conduction electrons due to electric field E
 - (c) repulsion to the conduction electrons due to inner electrons of ions.
 - (d) collision of conduction electrons with each other.

Ans. b

4. A cell having an emf E and internal resistance r is connected across a variable external resistance R . As the resistance R is increased, the plot of potential difference V across R is given by

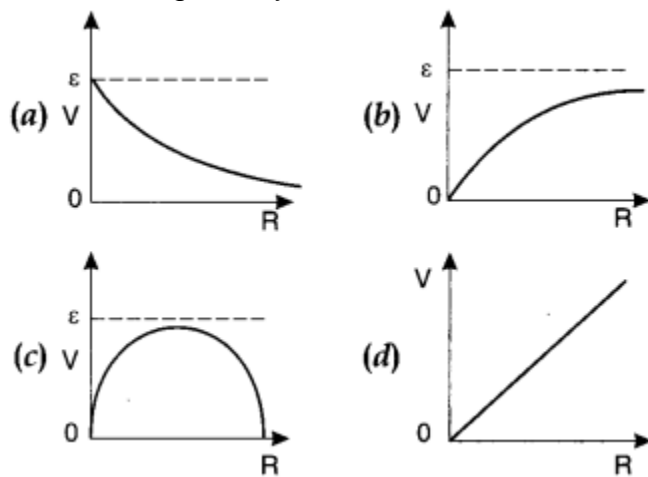

Answer-b

5. In parallel combination of n cells, we obtain
- (a) more voltage
 - (b) more current
 - (c) less voltage
 - (d) less current

Answer-b

6. If n cells each of emf e and internal resistance r are connected in parallel, then the total emf and internal resistance will be

- (a) $\varepsilon, \frac{r}{n}$ (b) ε, nr
(c) $n\varepsilon, \frac{r}{n}$ (d) $n\varepsilon, nr$

Answer- a

7. In a Wheatstone bridge if the battery and galvanometer are interchanged then the deflection in galvanometer will

- (a) change in previous direction
(b) not change
(c) change in opposite direction
(d) none of these.

Answer-b

8. When a metal conductor connected to left gap of a meter bridge is heated, the balancing point

- (a) shifts towards right
(b) shifts towards left
(c) remains unchanged
(d) remains at zero

Answer-a

9. The relaxation time in conductors

- (a) increases with the increases of temperature
(b) decreases with the increases of temperature
(c) it does not depend on temperature
(d) all of sudden changes at 400 K

Answer-b

10. The example of non-ohmic resistance is

- (a) diode
- (b) copper wire
- (c) filament lamp
- (d) carbon resistor

Answer- a

11. A charge is moving across a junction, then

- (a) momentum will be conserved.
- (b) momentum will not be conserved.
- (c) at some places momentum will be conserved and at some other places momentum will not be conserved.
- (d) none of these.

Answer- d

12. Which of the following I-V graph represents ohmic conductors?

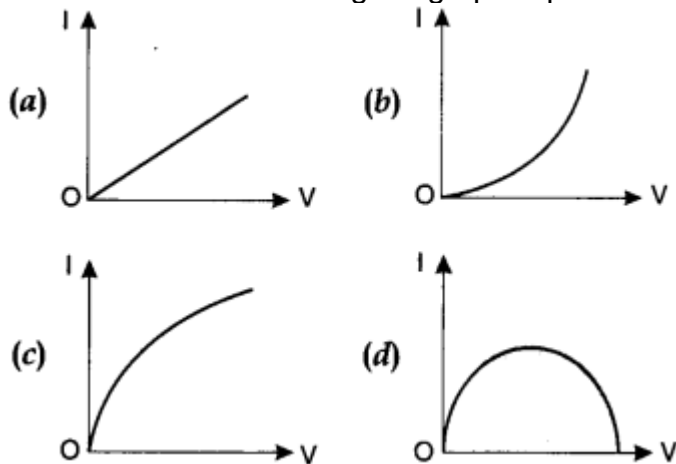

Answer-a

13. The I-V characteristics shown in figure represents

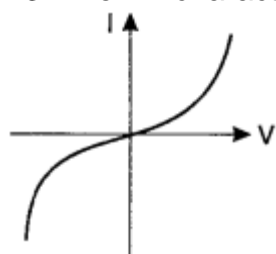

- (a) ohmic conductors
- (b) non-ohmic conductors
- (c) insulators
- (d) superconductors

Answer-b

14. Which of the following is correct for V-I graph of a good conductor?

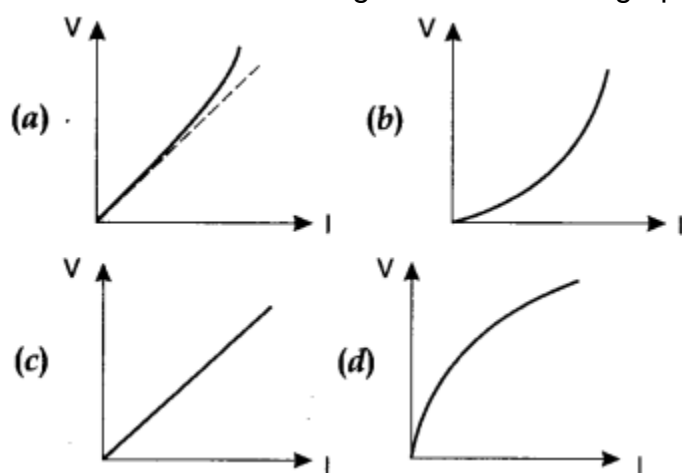

Answer-a

15. The resistivity of alloy manganin is

- (a) Nearly independent of temperature
- (b) Increases rapidly with increase in temperature
- (c) Decreases with increase in temperature
- (d) Increases rapidly with decrease in temperature

Answer-a

16. The magnitude and direction of the current in the circuit shown will be
 (a) $7/3$ A from a to b through e. (b) $7/3$ A from b to a through e.
 (c) 1 A from a to b through e.
 (d) 1 A from b to a through e.

Ans: - (c).

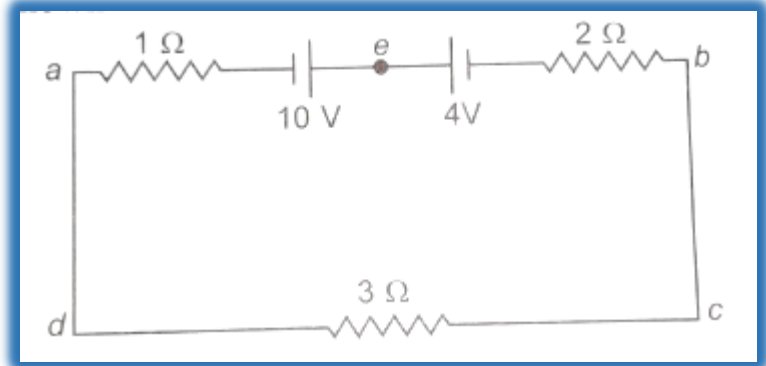

Since $E_1(10 \text{ V}) > E_2(4 \text{ V})$

So current in the circuit will be clockwise.

Applying Kirchoff's voltage law

$$-1 \times i + 10 - 4 - 2 \times i - 3i = 0 \Rightarrow i = 1 \text{ A (a to b via e)}$$

$$\therefore \text{Current} = \frac{V}{R} = \frac{10 - 4}{6} = 1.0 \text{ ampere}$$

17. Ohm's law is true for
 (a) For metallic conductors at low temperature.
 (b) For metallic conductors at high temperature.
 (c) for electrolytes when current passes through them.
 (d) For diode when current flows.

Ans: - (a).

18. In an experiment of meter Bridge, a null point is obtained at the center of the bridge wire. When a resistance of 10Ω is connected in one gap, the value of resistance in other gap is

- (a) 10Ω (b) 5Ω (c) 15Ω (d) 500

Ans: - (a).

19. The Terminal potential difference of a cell is greater than its e.m.f. when it is
 (a) Being discharged. (b) In open circuit.
 (c) Being charged. (d) Being either charged or discharged.

Ans: - (c).

20. A fuse wire is a wire of

- (a) Both low resistance and low melting point.
- (b) High resistance and low melting point.
- (c) Low resistance and high melting point.
- (d) Both high resistance and high melting point.

Ans: - (b).

21. In India electricity is supplied for domestic use at 220 V. It is supplied at 110 V in U.S.A. If the resistance of a 60 W bulb for use in India is $R \Omega$, then resistance of a 60 W bulb for use in U.S.A will be

- (a) $R \Omega$.
- (b) $2R \Omega$.
- (c) $R/4 \Omega$.
- (d) $R/2 \Omega$.

Ans: - (c).

Hints: - $R = V^2/P$.

22. A wire of resistance 10Ω is elongated by 10 %. The resistance of the elongated wire is

- (a) 10.1Ω .
- (b) 11.1Ω .
- (c) 12.1Ω .
- (d) 13.1Ω .

Ans: - (c).

Hints: - $R = \rho l/A = \rho l^2/Al = \rho l^2/V$, $R \propto l^2$.

23. Which of the following physical quantities possesses the dimensions of $M^{-1}L^{-3}T^3A^2$?

- (a) resistance.
- (b) resistivity.
- (c) conductivity.
- (d) emf.

Ans: - (c).

24. Given a current carrying wire of non-uniform cross section. Which of the following is constant throughout the length of the wire?

- (a) current, electric field and drift speed
- (b) current and drift speed
- (c) drift speed only
- (d) current only

Ans: - (d).

25. The potential difference between points A and B of given figure is.....

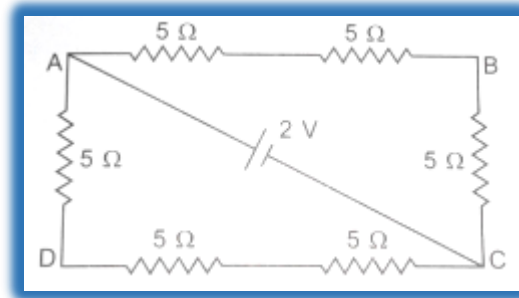

Ans: - (4/3 V)

Hints: - total resistance = 15/2 ohm.

Current through each branch = 2/15 A.

$V_{AB} = I \times \text{resistance of AB} = 2/15 \times 10 = 4/3 \text{ volt.}$

SECTION B(2 MARKS QUESTIONS)

1. Two conducting wires X and Y of same diameter across a battery. If the number density of electro in X is twice that in Y, find the ratio of drift velocity of electrons in the two wires.

Answer:

$$I = neA v_d \quad \therefore \frac{v_{d_x}}{v_{d_y}} = \frac{n_y}{n_x}$$

$$\text{As } n_x = 2n_y \quad \therefore \frac{v_{d_x}}{v_{d_y}} = \frac{1}{2}$$

2. An electric bulb is rated 220 V and 100 W. Power consumed by it when operated on 110 V is

Ans: - (25 W).

3. What is relaxation time? How is it related to the drift velocity of free electrons?

Ans: - the mean time interval of two consecutive collisions of free electrons with positive ion in a conductor. For constant electric field strength drift velocity is directly proportional to relaxation time.

4. 10 kWh = J.

Ans: - 3.6×10^7 J.

5. Two materials Si and Cu are cooled from 300 K to 60 K. What will be the effect on their resistivity?

Ans: -The specific **resistivity** of copper (metal) **will** decrease but that of **silicon** (semi-conductor) **will** increase.

6. Out of $V - I$ graph for parallel and series combination of two metallic resistors, which one represents parallel combination of resistors? Justify your answer.

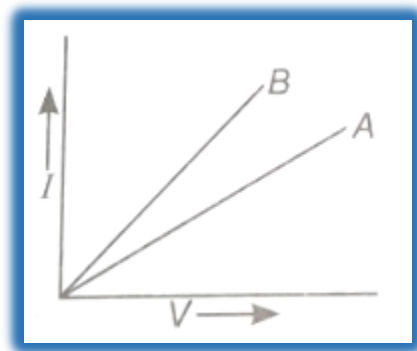

Ans: - A is series and B is in parallel, $R = \text{slope of } V\text{-}I \text{ graph}$.

7. It is easier to start a car engine on a warm day than on a chilly day. Why?

Ans: - On a **warm day** the temperature is higher as compared to **than on a chilly day**. The internal resistance of a **car** battery decreases with increase in temperature and hence, it becomes **easier to start a car engine**.

Or

What is the composition of materials used in the fuse wire?

Ans: - (63%tin and 37%lead)

8. A wire of resistivity ρ is stretched to double its length. What will be its new resistivity?

Ans: - (unchanged).

9. Show on a graph the variation of resistivity with temperature for a typical semiconductor.

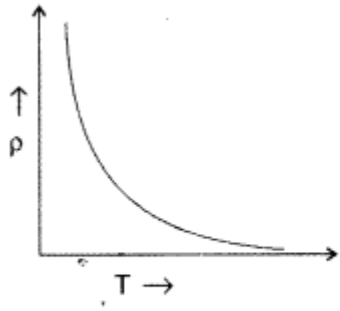

Ans. Resistivity of a semi conductor decreases rapidly with temperature.

SECTION – C (3 MARKS QUESTIONS)

1.(a) Plot a graph showing the variation of resistance of a conducting wire as a function of its radius, keeping the length of the wire and its temperature as constant.

Ans: - $R = \rho l/A$, $R \propto 1/r^2$

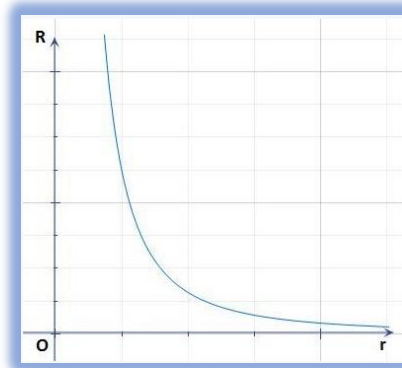

(b) $V - I$ graph for a metallic wire at two different temperatures T_1 and T_2 is as shown in the figure. Which of the two temperatures is higher and why?

Ans: - $R = V/I$ and varies directly to temperature.
At T_1 resistance is greater. ($T_1 > T_2$)

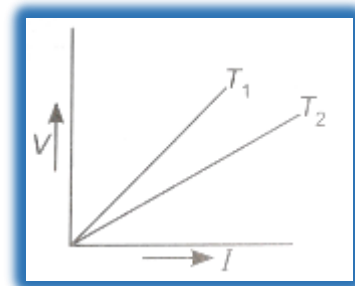

2. (a) Differentiate between EMF and terminal potential difference. The EMF of a cell is always greater than its terminal voltage. Why? Give reason.

Ans: -he emf of a cell is **greater than its terminal voltage** because there is some potential drop across the **cell** due to **its** small internal resistance.

(b) You are given three constantan wires P, Q and R of length and area of cross-section (L, A) , $(2L, A/2)$, $(L/2, 2A)$ respectively. Which has higher resistance?

Ans: - Q.

3. (a) Graph showing the variation of current vs voltage for a material GaAs is shown in the figure. Identify the region of

(i) negative resistance.

(ii) where Ohm's law is obeyed.

(b) Give an example of a material each for which temperature coefficient of resistivity is (i) positive and

(ii) negative.

(i) positive.

(ii) negative.

Ans: - (a) (i) DE (slope is negative and hence resistance).

(ii) BC (straight line)

(b) (i) Cu (metals, alloys).

(ii) Si (semiconductor).

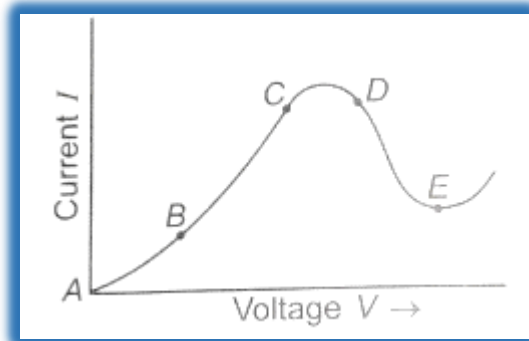

4. (a) Show variation of resistivity of copper as a function of temperature in a graph.

(b) the plot of the variation of potential difference across a combination of three identical cells in series, versus a current is as shown here. What is the EMF of each cell?

Ans: - (a)

(b) 2V.

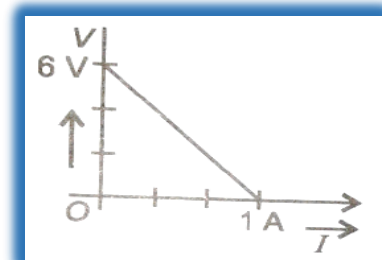
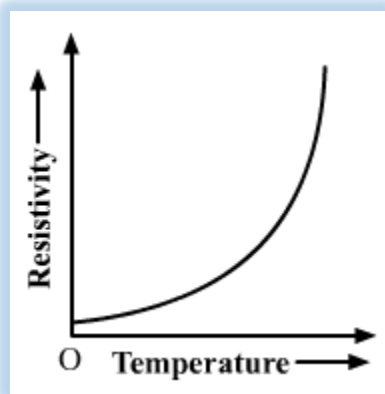

5. a) Two wires of equal length, one of copper and the other of manganin have the same resistance. Which wire is thicker?

(b) Write two characteristics of manganin, which make it suitable for making standard resistances.

$$\text{As } R = \frac{\rho l}{A} \quad \therefore A = \frac{\rho l}{R}$$

For both wires R and l are same and $\rho_{\text{copper}} < \rho_{\text{manganin}}$.

$\therefore A_{\text{copper}} < A_{\text{manganin}}$

Ans: - i.e. Manganin wire is thicker than copper wire.

Manganin has a constant electrical **resistance** over a wide range of temperature that is a small value of temperature coefficients. This **makes** it has same **resistance** even if **resistance** is heated up.

Or

Define mobility of electron in a conductor. How does electron mobility change when (i) temperature of conductor is decreased?

(ii) and applied potential difference is doubled at constant temperature?

Ans: - drift velocity per unit electric field applied is termed as mobility.

- (i) When **temperature** of the **conductor decreases**, the relaxation time τ of the **electrons** in the **conductor** increases, so **mobility** μ increase.
- (ii) **Mobility** μ is independent of **applied potential difference**.

6.State the two Kirchhoff's rule used in electric networks. How are these rules justified?

- Ans: - K1L- The algebraic sum of total current into any junction of an electric circuit is zero.

$$\sum I = 0 \quad (\text{junction rule, valid at any junction})$$

- K2L-The algebraic sum of the potential differences in any loop, including those associated with emfs and those of resistive elements, must equal zero.

$$\sum V = 0 \quad (\text{loop rule, valid for any closed loop})$$

Or

In the circuit shown in the figure, find the total resistance of the circuit and the current in the arm CD.

Hints: -current through the capacitor (CE) is zero hence branch CEF is not worth in the circuit.

So, equivalent resistance is 5Ω .

Total current is 3A.

Current in CD = $\frac{1}{2}$ A.

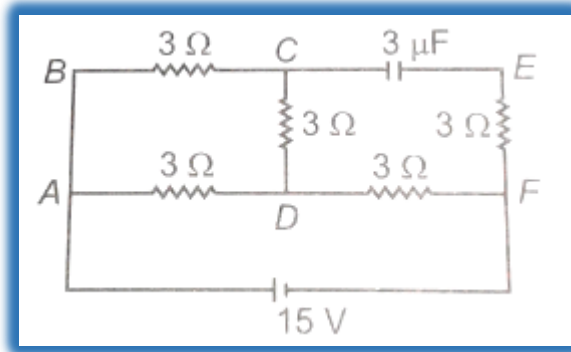

7. Define relaxation time of the free electrons drifting in a conductor. How is it related to the drift velocity of free electrons?

Ans: -The average **time** elapsed between two successive collisions is known as the **relaxation time of free electrons drifting in a conductor**.

Or

Find the charge on the capacitor as shown in the circuit.

Hints: - equivalent resistance = 30Ω .

Current = $\frac{1}{15}$ A.

Potential difference between ends of capacitor = $\frac{1}{15} \times 10 = \frac{2}{3}$ volt.

Charge on capacitor, $q = CV = \frac{2}{3} \times 6\mu\text{C} = 4\mu\text{C}$.

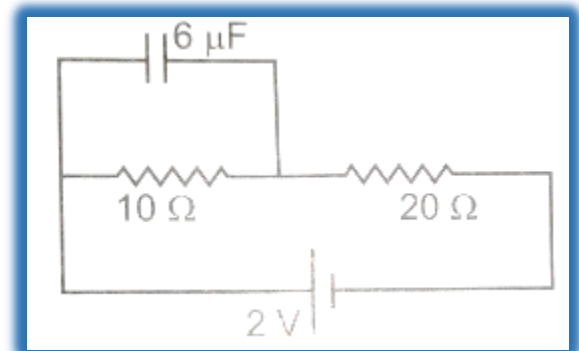

SECTION – D(5 MARKS QUESTIONS)

1. In the circuit shown in the figure, the galvanometer G gives zero deflection. If the batteries A and B have negligible internal resistance, find the value of the resistor R.

Hints: - if galvanometer gives zero deflection, it means source of current by 12 V across R and voltage across R is 2V.

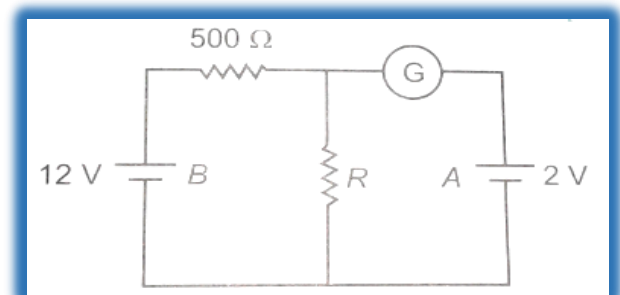

$$\text{Current in the circuit } I = \frac{\varepsilon}{R_1 + R_2} = \frac{12.0V}{500 + R}$$

and

$$V = IR = 2.0V$$

$$\left(\frac{12.0V}{500 + R}\right)R = 2.0$$

$$12R = 1000 + 2R$$

$$10R = 1000$$

$$\Rightarrow R = 100 \Omega$$

2. In the given circuit with a steady current, calculate the potential difference across the capacitor and the charge stored in it.

Hints: - first remove branch BE and find the current in the circuit as, $6V / 3\Omega = 2A$.

Now take a closed loop as ABEFA or BEDCA and apply loop law to find voltage of capacitor and then charge.

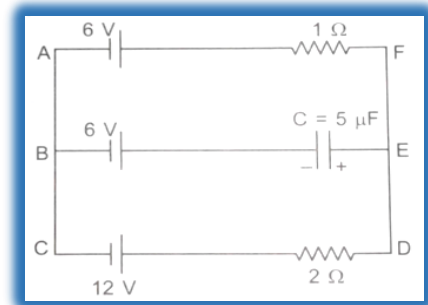

3. First a set of 'n' equal resistors of 'R' each are connected in series to a battery of emf 'E' and internal resistance 'R'. A current I is observed to flow. Then the n resistors are connected in parallel to the same battery. It is observed that the current is increased 10 times. What is n?

Ans: - 10.

Hints: - for series combination, $R_s = nR$, with cell total resistor = $nR + R =$

$$(n + 1) R, \text{ current, } I = \frac{E}{(n + 1)R} \dots\dots\dots(i)$$

Now for parallel combination,

$$R_p = R/n. \text{ with cell total resistance } = \frac{R}{n} + R = \frac{(n + 1) R}{n} .$$

$$\text{Current } I' = E / \frac{(n + 1) R}{n} = \frac{nE}{(n + 1) R} \dots\dots\dots(ii)$$

From (i) & (ii), $I' = nI$.

Hence, $n = 10$.

4. Heating element is marked 210 V, 630 W. What is the value of the current drawn by the element when connected to a 210 V dc source.

Hints: - $p = VI$, $I = p/V = 3A$.

Or

An emf of a cell is 1.5 V and its internal resistance is 1 Ω . For what current drawn from the cell will its terminal potential difference be half of its emf?

Hints: - $V = E - Ir$, but, $V = E/2$,

then $E/2 = E - Ir$ or $E/2 = Ir$ or, $I = E/2r = 1.5/2 \times 1 = 0.75A$.

5. Calculate the value of the resistance R in the circuit shown in the figure so that the current in the circuit is 0.2 A. What would be the potential difference between points A and D?

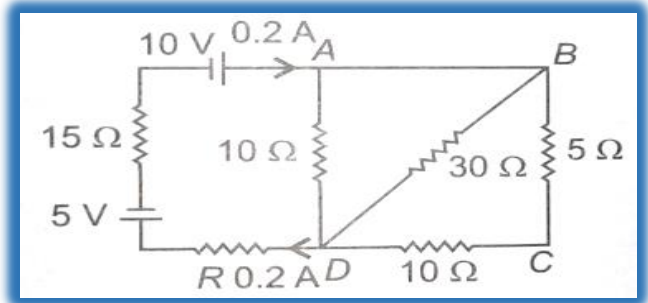

Hints: - equivalent resistance between B and D is 10 Ω . It means 0.2 A of current is divided into two equal parts of 0.1 A.

Now applying loop law for closed path containing batteries and resistor R.

$$-5 - (15 \times 0.2) + 10 - (10 \times 0.2) - 0.2 R = 0,$$

$$R = 5 \Omega$$

6. (i) Derive an expression for drift velocity of electrons in a conductor. Hence deduce Ohm's law.

(ii) Cross sectional area is increasing linearly from its one end to the other is connected across a battery of V volts. Which of the following quantities remain constant in the wire?

- | | |
|----------------------|---------------------|
| (a) drift speed | (b) current density |
| (c) electric current | (d) electric field |

Justify your answer.

Hints: - (i) refer to drift velocity, (ii) The **electric current will remain constant**.

Because **current** is the only **quantity** that does not depend on the **area of cross-sections** of the **wire**.

7. (a) Define the term drift velocity of charge carriers in a conductor. Obtain the expression for the current density in terms of relaxation time.

(b) A 100 V battery is connected to the electric network as shown. if the power consumed in the 2 Ω resistor is 200 W. Determine the power dissipated in the 5 Ω resistor.

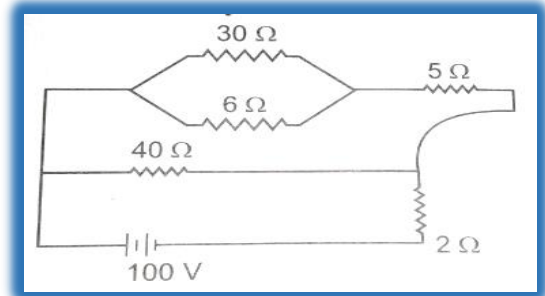

Hints: - (a) Refer to class notes.

(b) Equivalent resistance of the circuit is 10 Ω. hence current is 10 A.

Current across, 5 Ω is 8 A, $p = I^2R = 64 \times 5 = 320 \text{ W}$.

Or

(a) State Kirchhoff's law of an electrical network.
 (b) Using Kirchhoff's laws, Calculate the potential difference across the 8 Ω resistor.

Hints: - Let I_1 is the current through the cell of 4 V
 I_2 is the current through 6 V.
 So current through 8 ohms is $I_1 + I_2$.

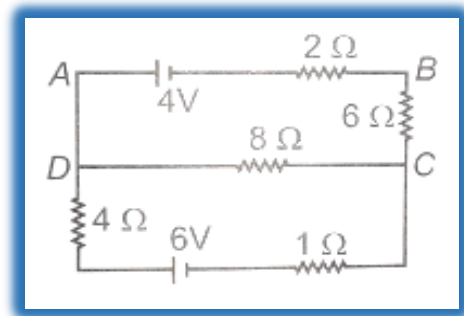

Taking the loop of first loop,

$$-4 + 2 I_1 + 8 (I_1 + I_2) + 6 I_1 = 0$$

$$4I_1 + 2I_2 = 1 \dots\dots\dots (i)$$

Taking the loop of second loop,

$$-6 + 4 I_2 + 8 (I_1 + I_2) + 1I_2 = 0$$

$$13I_2 + 8I_1 = 6 \dots\dots\dots (ii)$$

Solving both, we get, $I_1 = 1/36\text{A}$ and $I_2 = 4/9\text{A}$,

Total current across 8Ω resistor = $I_1 + I_2 = 17/36\text{A}$.

$$V = IR = 17/36 \times 8 = 34/9 \text{ volt.}$$

CASE STUDY BASED QUESTIONS

Read the following source and answer any four out of the following questions:

Resistance is a measure of the opposition to current flow in an electrical circuit. Resistance is measured in ohms. Also, Resistivity, the electrical resistance of a conductor of unit cross-sectional area, and unit length. ... A characteristic property of each material, resistivity is useful in comparing various materials on the basis of their ability to conduct electric currents.

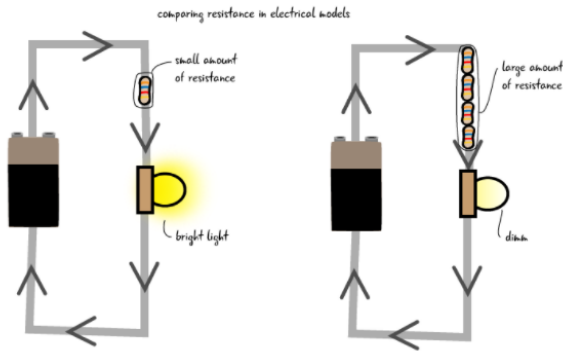

1. Resistivity is independent of:

- a) nature of material
- b) temperature
- c) dimensions of material
- d) none of the above

2) As compare to short wires, long wires of the same cross section and material have _____ resistance.

- a) more
- b) less
- c) same
- d) zero

3)As compare to thin wires, thick wires of the same length and material have _____ resistance.

- a) more
- b) less
- c) same
- d) zero

4)The resistance of a wire depends upon:

- a. cross-sectional area
- b. length of wire
- c. wire's nature
- d. all of the above

5)A copper wire having the same size as steel wire have:

- e. more resistance
- f. less resistance
- g. same resistance
- h. none of the above

ASSERTION REASONING QUESTIONS

Directions: These questions consist of two statements, each printed as Assertion and Reason. While answering these questions, you are required to choose any one of the following four responses.

- (a) If both Assertion and Reason are correct and the Reason is a correct explanation of the Assertion.
- (b) If both Assertion and Reason are correct but Reason is not a correct explanation of the Assertion.
- (c) If the Assertion is correct but Reason is incorrect.
- (d) If both the Assertion and Reason are incorrect.

Q.1. Assertion: In a simple battery circuit, the point of the lowest potential is positive terminal of the battery.

Reason : The current flows towards the point of the higher potential, as it does in such a circuit from the negative to the positive terminal.

Answer - d

Q.2. Assertion: A larger dry cell has higher emf.

Reason: The emf of a dry cell is proportional to its size.

Answer- d

Answer

Q.3. Assertion: Voltmeter is connected in parallel with the circuit.

Reason: Resistance of a voltmeter is very large.

Answer - b

Q.5. Assertion: Ohm's law is applicable for all conducting elements.

Reason: Ohm's law is a fundamental law.

Answer - c

Q.6. Assertion: An electric bulb becomes dim, when the electric heater in parallel circuit is switched on.

Reason: Dimness decreases after sometime.

Answer-b

TERM-1- 2021-22-BOARD QUESTIONS

1. Kirchhoff's first rule $\Sigma I = 0$ and second rule $\Sigma IR = \Sigma E$ (where the symbols have their usual meanings) are respectively based on -

- (a) conservation of momentum and conservation of charge
- (b) conservation of energy, conservation of charge
- (c) conservation of charge, conservation of momentum
- (d) conservation of charge, conservation of energy

Answer: (d)

2. The electric power consumed by a 220 V - 100 W bulb when operated at 110 V is

- (a) 25 W
- (b) 30 W
- (c) 35 W
- (d) 45 W

Answer: (a)

3. Which of the following has a negative temperature coefficient of resistivity?

- (a) metal
- (b) metal and semiconductor
- (c) semiconductor
- (d) metal and alloy

Answer: (c)

4. If n , e , τ , and m have their usual meanings, then the resistance of a wire of length l and cross-sectional area A is given by

$$R = \left(\frac{m}{ne^2 \tau} \right) \frac{l}{A}$$